

NEWPRINT/Multi Installation & User Guide For firmware v2.0.1

Virtual Printer Adapter
04/29/2026

Plaid Vest Software, LLC
www.plaidvest.com

Version History

- v2.0.1 04/29/2026
 - Minor FX-80 fixes. Graphics speedup (2.5x).
- v2.0.0 03/31/2026 (Beta)
 - Epson FX-80 printer support (text and graphics)
- v1.4.3 2025-09-17
 - Updated Expressif ESP32 and 3rd party libraries
 - Treat 0xff (linux lp eof) as \r (LF) during command mode processing
 - Remove remote html option
 - Lightened green in GUI black/green display colors
- v1.4.2 2023-04-17
 - Fixed RTF ampersand character in output .rtf file
- v1.4.1 2023-04-17
 - Blank line fix for IIGS graphics when using older Grappler+ cards (G+Fix)
 - New display color options (white on black, green on black)
 - Renamed formats: "AppleWorks" to "Document" and "PrintShop" to "Graphics" to better reflect multiple retro machine support.
- v1.4 2023-03-31
 - New AppleWorks output format
 - AppleWorks Rich Text (RTF) option for display and saved output file
- v1.3 2022-03-09
 - GS/OS support (for Apple IIGS)
- v1.2 (Unreleased)
 - Print Shop GS support (for Apple IIGS)
- v1.1 2022-02-20
 - Print Shop support (for Apple II)
- v1.0 2021-08-28
 - Initial version

IMPORTANT NOTE:



Please make sure to power off your computer before attaching the NEWPRINT printer interface cable.

You may damage NEWPRINT or your computer if you connect or disconnect the printer cable while the computer is on.

Plaid Vest Software, LLC is not responsible or liable for any damage caused by NEWPRINT. If you are not comfortable performing the installation and/or power connections please return your adapter for a full refund (less shipping charges).

Package Contents:

- NEWPRINT/Multi interface board
- 34 pin straight-through ribbon cable (included)
(TRS-80 34 pin edge, Apple II 26 pin IDC, or Centronics 36 pin female)
- USB to Barrel connector power cable
- Protective lower base
- Quickstart sheet

Notes:

- NEWPRINT only works with 2.4Ghz Wifi networks. 5Ghz wifi is not supported.
- The ESP32 microcontroller on your board may use a USB-C or Micro-USB connector depending on availability
- The NEWPRINT power switch is ignored when directly powering the microcontroller via USB cable.
- **Only use one power source at a time (ie. when updating firmware do not use an external power cable. The USB cable to your computer will power the NEWPRINT board.)**
- Apple II series requires a Grappler+ printer card (or compatible).
- See Grappler+ section for dip switch settings and IIGS compatibility notes.
- NEWPRINT emulates an ImageWriter printer when in Graphics/Document mode. This format is also used by C.Itoh 8510 and possibly other printers. Epson FX-80 printer for Graphics/Document modes is also supported.
- **Other vintage machines may be supported.** I have had reports of Atari and C64 machines working when used with a Supergraphix Centronics printer adapter. This support is not guaranteed as I do not have these machines to test with. I have had success with USB-to-Parallel cables with PC, macOS, and Linux.

Limitations

- TRS-80 supports text only (no graphics or formatted documents)
- Apple II Series requires a Grappler+ (or compatible) card
- Apple II AppleWorks support is for the text-only "classic" version 1.2+
- Apple II+, IIe supports text, AppleWorks, and Print Shop graphics
- Apple IIGS supports Apple II (as above) plus Print Shop/GS and GS/OS graphics output (requires Harmonie printer drivers)

TRS-80 Notes

- Graphics are not supported when using NEWPRINT/Multi on a TRS-80.
- Output for TRS-80 machines is **text only** at the moment.

Apple IIGS Notes:

- Some IIGS models may require a "newer" Grappler+ card (with 74LS374 in U10).
- The "old" Grappler+ card (with 74LS373 in U10) **may** have timing issues on the GS.
- My setup is a ROM01 IIGS with the older (373) Grappler+ card and I have no issues.
- See this link for Apple's Tech Note on this issue:
<https://support.apple.com/kb/TA36748>
- If you are using one of the older Grappler+ cards (373 chip), set dip switch 1 to OFF.
- If you are using one of the newer Grappler+ cards (374 chip), set dip switch 1 to ON.
- The GUI has a "G+ Fix" option if you are using an older style Grappler card.

Apple II, IIGS Cable Installation:

Feeding the NEWPRINT cable through the rear slots on some Apple II computers can seem difficult.

However, it is very possible (and fairly easy). See "Apple II - Rear port ribbon cable installation" section below for a few pictures and tips on how to install the ribbon cable through the rear slots without damaging your cable.

Table of Contents

Limitations	3
TRS-80 Notes	3
Apple IIGS Notes:	3
Apple II, IIGS Cable Installation:	3
Description	5
Hardware	6
Connecting NEWPRINT To Your Machine	7
Grappler+ Setup for Apple II Series (including IIGS)	7
Connecting NEWPRINT To Your Network	10
The NEWPRINT Web Interface	11
(A) Action Buttons	12
(B) Display Options	13
(C) Output Window	15
(D) Log Window	15
Sending Commands to NEWPRINT	15
User Commands (Computer → NEWPRINT)	15
Advanced/Experimental User Commands	16
WebSocket Commands (web interface → NEWPRINT)	17
Resetting NEWPRINT To Factory Defaults	17
Apple II Grappler+ Settings	18
Apple II AppleWorks Classic (v1.2+) Settings	18
Apple IIGS printing with GS/OS (Harmonie Drivers)	19
Writing a Custom Interface	19
Firmware Updates	20
Parallel Port Pinout	21
FAQ (Frequently Asked Questions)	21
Contact/Questions/Comments/Bugs	22

Description

NEWPRINT is a wifi-enabled "virtual" printer adapter for TRS-80 Model 1, 3, 4, or 4P or Apple IIe/IIGs with a Grappler+ (or compatible) printer card. It may also work on other vintage computers that use a standard parallel interface. NEWPRINT connects to the computer's printer port and your local wifi network to send printer output to any device that supports a modern browser (iPad, Desktop PC, Mac, etc.).

The NEWPRINT web interface can show printer output as plain text, hexadecimal values, basic formatting (.rtf output), or graphics (emulates a 4-color ImageWriter and black-and-white Epson FX-80). Apple IIGS GS/OS generic graphics printing is also supported. In Document mode some basic formatting features are supported (bold, italics, underline) depending on printer type and host printer drivers.

By default, when in ASCII or DOS modes any non-ASCII (ie. printer control code) characters are hidden. When in ASCII mode you have the option to show these characters either as hex values (ie. "{0E}") or as symbolic "{LF}" characters.

After you enter your wifi credentials (SSID and password - see instructions below) the NEWPRINT web interface will be available from any browser in your local wifi network at: newprint.local

NEWPRINT uses the standard HTML WebSocket API so you can even write your own web-based or desktop interface for displaying and processing NEWPRINT output.

NEWPRINT can emulate ImageWriter or Epson FX-80 printers when in Graphics or Document modes. However, not all commands are supported.

Other vintage machines may be supported. I have had reports of Atari and C64 machines working when used with a Supergraphix Centronics printer adapter. This support is not guaranteed as I do not have these machines to test with.

I have had success with USB-to-Parallel cables with PC, macOS, and Linux.

Hardware

NEWPRINT Adapter

NEWPRINT connects to your computer's parallel printer port using a 34-pin ribbon cable. Printer data is read by the NEWPRINT and transmitted via wifi to an onboard web server. This server provides a web-based interface on your local network where the printer output can be viewed or saved using any modern browser.

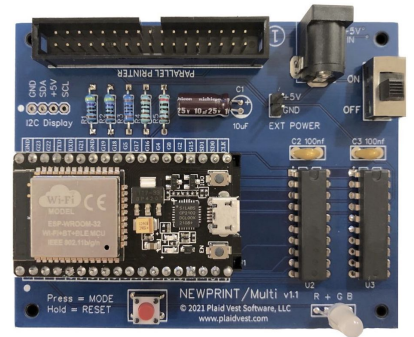

Power

NEWPRINT requires a USB +5 Volt DC power source. This can be provided using the USB-C port (standard cellphone charger), a center-positive 5.5x2.1mm barrel connector to USB (included), or "EXT POWER" jumper pins. The On/Off switch is not used when powering with the USB-C port.



Ribbon Cable

The NEWPRINT connector is a female 34-pin IDC connector. The TRS-80 connector is a 34-pin **non-keyed** female edge connector. The Apple II (with Grappler+ printer card) uses a female 26-pin IDC connector.



The Command Button (SW1)

NEWPRINT uses a pushbutton switch to perform several actions:

- Push briefly to toggle between "Normal" and "Command" mode
 - Normal mode: Green  or Red  LED
 - Command mode: Blue  LED
- Hold for 3+ seconds = Reset to factory defaults. This will erase all of your custom settings including wifi network name (SSID) and password.

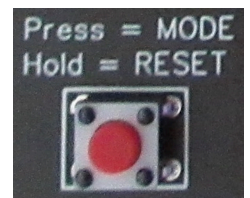

The Status LED

NEWPRINT uses a multicolor LED to indicate its current status:

Green  = connected to wifi

Red  = error connecting to to wifi (SSID and/or password is invalid)

Blue  = Command mode. Any printer output will be interpreted as NEWPRINT commands

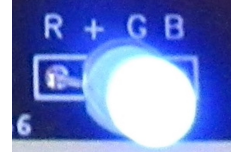

Note: The "Status LED" is different than the tiny red power LED on the ESP32 microcontroller. When this guide refers to "the LED" it is referring to this large multicolor Status LED marked as "LED1" on the NEWPRINT board.

Connecting NEWPRINT To Your Machine

Step 1 (For TRS-80 - Model 3 example):

Connect your 34-pin printer ribbon cable to the underside of your TRS-80 as shown.

The printer port is the connector nearest the back of the case on the side with the power switch.

Pin #1 of the cable (usually a red wire) goes on the power switch side of the TRS-80.

Note: Be careful to align pin #1 of the printer cable matches pin #1 of the printer port. Pin #1 is usually marked with a red wire.

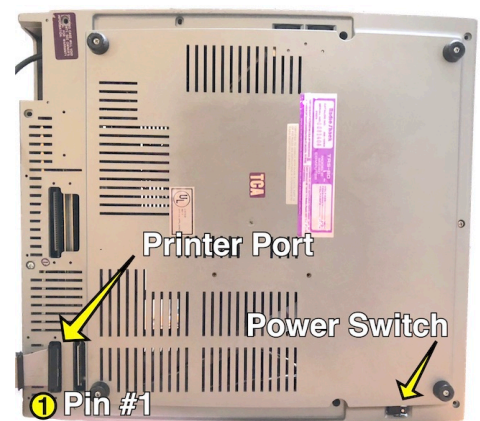

Grappler+ Setup for Apple II Series (including IIGS)

Step 1 (for Apple II series):

You may want to wait until after initial setup and testing before attempting to feed the NEWPRINT ribbon cable through a back port on your Apple II computer. While not difficult, it can be a little tricky. Once you confirm that your NEWPRINT is working properly then follow the instructions below to feed the cable through the rear port for a more permanent installation.

Connect your 26-pin printer ribbon cable to the Grappler+ card. Please note that pin #1 is toward the keyboard.

Pin #1 of the cable (usually a red wire) goes on the keyboard (left) side of the Grappler+ connector.

Notes: Be careful to align pin #1 of the printer cable to pin #1 of the printer connector.

Grappler+ Dip Switch Settings:

- "older" Grappler+ with 74LS373 chip in U10 need to have 1=Off
- "newer" Grappler+ card with 74LS374 chip in U10 need to have 1=On
- Remaining switches should be set as 2=On, 3=On, 4=On

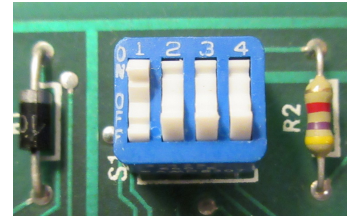

NOTE: Some IIGS computers **may** need a "newer" Grappler+ card due to timing issues. See this Apple Tech note for details: <https://support.apple.com/kb/TA36748>.

A fix for this issue has been implemented in the NEWPRINT web interface.

If you have issues with blank lines showing on your graphics output when using an Apple IIGS with an older Grappler+ card you can enable the G+Fix option. This will duplicate the 7th data bit instead of using the unreliable 8th bit. The output won't be perfect, but it should provide a very acceptable image.



NEWPRINT/Multi has been tested on a ROM 01 GS with the "older" Grappler+ card with no issues so your results may vary.

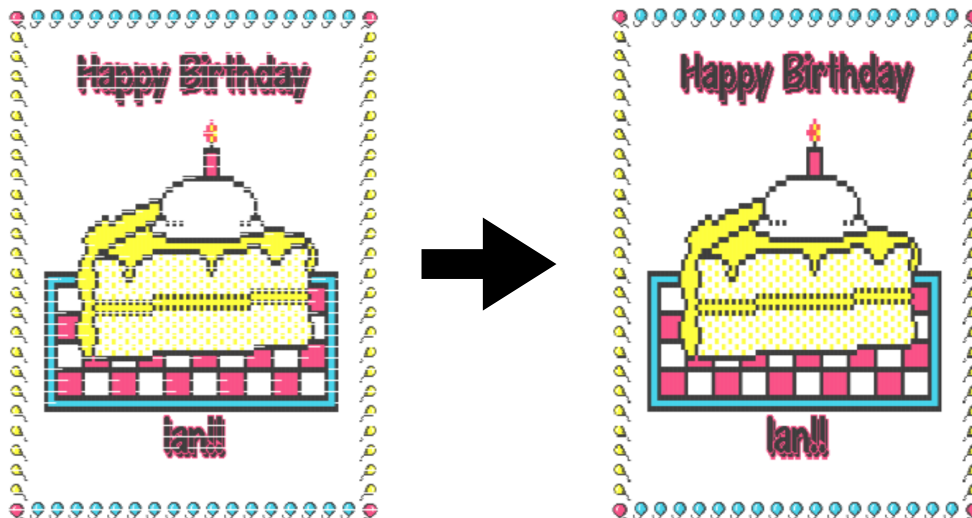

Connection Step 2:

Connect the ribbon cable to your NEWPRINT.

Note: Be careful to align pin #1 of the printer cable to pin #1 of the NEWPRINT connector (Next to power jack). Ribbon cable pin #1 is usually marked with a red wire.

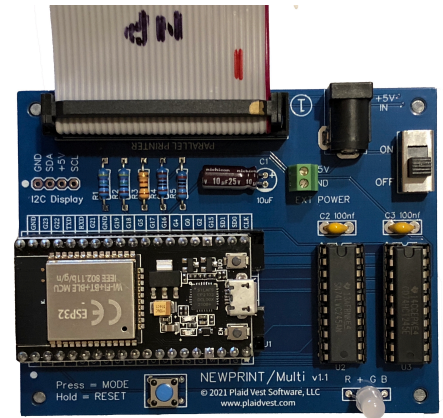

Connection Step 3: Apply +5V power: Three options exist:

- Direct to ESP32 via USB-C (ie. cell phone charger)
- USB via Center-positive 5.5x2.1mm barrel connector cable (included)
- External (regulated) +5v DC via 2-pin power header

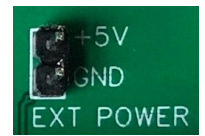

Note: When using option A (USB-C) the on/off switch is not functional.

ONLY USE ONE POWER SOURCE AT A TIME

The ESP32 microcontroller has a very tiny, very bright, red power LED next to the USB-C port that should be lit whenever your NEWPRINT is connected to power. This is **not** the NEWPRINT Status LED.

After a moment, the large NEWPRINT Status LED should light up.

Note: The large Status LED will be red when connected for the first time. This indicates that your NEWPRINT is **not** connected to a wifi network (due to missing wifi credentials).

Connecting NEWPRINT To Your Network

When you first power on your NEWPRINT the large Status LED should be red . This indicates that NEWPRINT is not connected to your wifi network.

Follow these steps to provide your wifi credentials to the NEWPRINT adapter:



- 1) On your **TRS-80**, enter the BASIC environment. This can usually be accomplished by holding the <BREAK> key and resetting your machine. Or, if you are in DOS, type:



BASIC

On your **Apple II**, enable the printer by typing:

PR#1

Apple II Notes: The Apple II echos all output directly to the printer so you do not need LPRINT or quotes around the commands. You will see a "SYNTAX ERROR" on the Apple II monitor after entering NEWPRINT commands. This is normal as the NEWPRINT commands are not Applesoft BASIC commands.

- 2) Press the NEWPRINT command button briefly. The LED should turn blue . This indicates you are in "COMMAND" mode and any printer commands will interpreted as commands. Pressing the command button again will toggle back to "NORMAL" mode (red  or green  LED).

Note: After you enter a command in "COMMAND" mode, the LED will blink once indicating the result of your command: green  = valid, red  = invalid. After the single blink, it will turn back to blue  indicating you are still in command mode.

- 3) Make sure the LED is blue . Enter your wifi network name (SSID) by typing:
TRS-80: **LPRINT "SSID=xxx"** (Replace xxx with your actual SSID name)
Apple II: **SSID=xxx** (Replace xxx with your actual SSID name)

Note: If your SSID contains characters that you cannot type on your keyboard use the SSIDHEX command instead. See the Commands section below for details.



- 4) Make sure the LED is blue . Enter your wifi password by typing:
TRS-80: **LPRINT "PASS=xxx"** (Replace xxx with your actual password)
Apple II: **PASS=xxx** (Replace xxx with your actual password)

Note: If your password contains characters that you cannot type on your keyboard use the PASSHEX command instead. See the Commands section below for details.

- 5) Finally, reboot NEWPRINT to connect to wifi using your new credentials. You can reboot by pressing the tiny "EN" button on the ESP32 microcontroller (next to the USB-C port) or by issuing the REBOOT command.

TRS-80: **LPRINT "REBOOT"**

Apple II: **REBOOT**

- 6) After NEWPRINT reboots the LED should be green  if the wifi connection is successful. If it is red , please press the command button once to re-enter command mode (blue  LED) and retry entering your SSID and password described above. Remember if you need any special characters, you need to use the SSIDHEX and PASSHEX commands.

NOTE: You can monitor the NEWPRINT commands by connecting your NEWPRINT to a PC or Mac computer with a MicroUSB cable and opening a serial connection (at 115200 baud). You should see NEWPRINT status messages and any command/values you are entering. The MicroUSB cable will also power the NEWPRINT at the same time.

If you still cannot connect please contact support@plaidvest.com for assistance.

The NEWPRINT Web Interface

Printer output is sent to your local network over wifi via a server running on the NEWPRINT ESP32 microcontroller. The server creates a DNS name of newprint.local

Navigating to this address in a web browser will show the NEWPRINT web interface.

From here you can view your printer output or send commands to NEWPRINT.

Advanced users can even write their own web or desktop interface application using the standard HTML WebSocket API.

The screenshot shows the NEWPRINT web interface in a browser window. The address bar displays 'newprint.local'. The interface is divided into several sections:

- Section A (Action Buttons):** Contains buttons for 'Clear Screen', 'Reload Screen', 'Copy to Clipboard', 'Save Output', 'Clear All', 'Send Command', 'Reboot NP/Multi', 'Save Defaults', and a 'Log' toggle switch.
- Section B (Format and Encoding):** Includes 'Format' (set to ASCII), 'Ctl Codes' (set to Hide), 'Wrap' (toggle), 'Encoding' (set to Apple IIe), and 'Paper Color' (set to white).
- Section C (Printer Window):** Displays a BASIC program for printing snail statistics. The code includes comments and commands for printing headers, statistics, and a final summary. The program ends with 'END'.
- Section D (Log Window):** Shows a log of connection events, including IP address, port, firmware version, GUI version, signal strength, and buffer status.

(A) Action Buttons

- **Clear Screen** - Clear the printer window. Does not clear the printer buffer.
- **Reload Screen** - Reload printer window from printer buffer.
- **Copy to Clipboard** - Copies the current printer window data to the clipboard.
- **Save Output** - Save the printer window data to a file on your device. Output is based on the current display format: ASCII/DOS as .txt, HEX as .bin, PrintShop as .pdf
- **Clear All** - Clears the printer window and printer buffer.
- **Send Command** - Send a NEWPRINT command. You do not need to be in command mode when sending commands from the web interface.
- **Reboot NP/Multi** - Restart NEWPRINT. Page will automatically refresh in 10 seconds.
- **Save Defaults** - save the current web interface settings to local browser storage. These settings will be cleared if you clear the cache of your browser or upon closing the window if you are using private browsing mode.
- **Paper Color** - Set the paper color to use in the printer window.
- **Log** - Show or hide the log window.
- **Collapse Controls Button** - Toggle the command buttons/listboxes on or off. Used to save screen space on smaller devices (phone/tablet).

(B) Display Options

- Format** - ASCII, DOS, HEX, Document, or Graphics. When in ASCII mode you can choose how to display control codes and enable/disable wrapping text to the window width. When in DOS mode you can wrap lines at 40, 64, or 80 columns. When in HEX mode the output window is always wrapped to the window width. Document mode supports very basic formatting and .RTF output when saving. Graphics mode on ImageWriter supports 4-colors while on FX-80 output is black and white only.

HEX Format:

```
6C 69 73 74 0D 0A 0D 0A 20 31 30 20 20 48 4F 4D 45 20 0D 0A 20 32 30 20 20 46 4F 52 20 58
20 3D 20 31 20 54 4F 20 35 0D 0A 20 33 30 20 20 50 52 49 4E 54 20 22 48 65 6C 6C 6F 20 66
72 6F 6D 20 41 70 70 6C 65 20 49 49 65 20 0D 0A 20 20 20 20 28 77 2E 47 72 61 70 70 6C
65 72 2B 29 22 0D 0A 20 34 30 20 20 4E 45 58 54 20 58 0D 0A 20 35 30 20 20 45 4E 44 20 0D
0A 0D 0A 5D 72 75 6E 0D 0A 48 65 6C 6C 6F 20 66 72 6F 6D 20 41 70 70 6C 65 20 49 49 65 20
```

ASCII/DOS Format:

```
list
10 HOME
20 FOR X = 1 TO 5
30 PRINT "Hello from Apple IIe
(w.Grappler+)"
```

- Control Codes** - ASCII mode only. These settings controls how non-printable (ie. printer control codes) are displayed.

"Hide" = Do not show

```
list
10 HOME
20 FOR X = 1 TO 5
```

"{0x}" = Show as hex values

```
list{0D}{0A}
{0D}{0A}
10 HOME {0D}{0A}
20 FOR X = 1 TO 5{0D}{0A}
```

"{NUL}" = Show as symbols

```
list{CR}{LF}
{CR}{LF}
10 HOME {CR}{LF}
20 FOR X = 1 TO 5{CR}{LF}
```

- Wrap** - ASCII mode only. Control if printer output is wrapped to the window or not. Output is always wrapped when in HEX mode. DOS mode uses 64/80 column option.
 - Encoding** - ASCII table to use. Options for ASCII, Apple II+/IIe, or TRS-80 M1/3/4
- NOTE:** TRS-80 Model 1 and Model 3 computers send a "@" (64d/40h) instead of the back-tick "`" (96d/60h) character.

GRAPHICS Format (Not supported on TRS-80):

- **Reset Printer** - Graphics mode only. Clears printer settings (ie. color, line height).
- **Form Feed** - Graphics mode only. Advances to a new page.
- **Line Feed** - Graphics mode only. Advances to a new line.
- **Wide Paper** - 14" wide paper (132 columns).
- **IIGS** - ImageWriter only. Enable Apple IIGS mode. This adjusts a few printer settings for more accurate output when using an Apple IIGS (ie. page margins).
- **G+Fix** - ImageWriter only. Enable Grapppler+ fix for IIGS computers that have blank lines in the graphics output. This duplicates the 7th data bit and ignores the unreliable 8th data bit. Only use this if you are seeing blank lines in your graphics output.

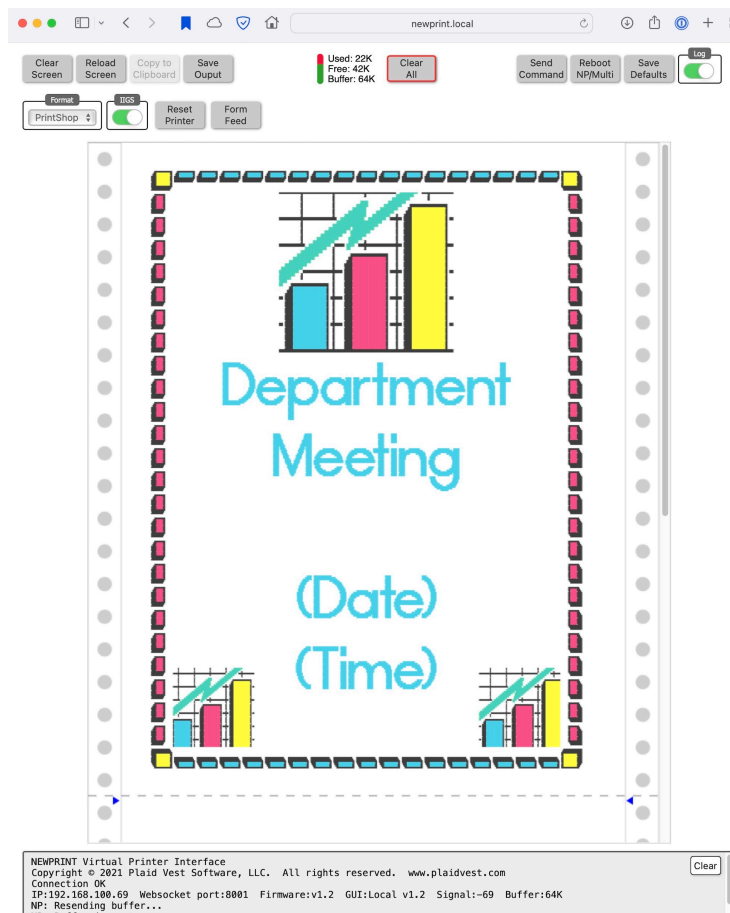

DOCUMENT Format (Not supported on TRS-80):

This format will interpret basic control codes (bold, underline, italics, super and sub-script).

- **Wrap** - Control whether or not printer output is wrapped to the browser window width.
- **PageBreaks** - Insert an extra line indicating where the Document output page ends.

(C) Output Window

Any printer output will appear here. By default, printer control codes (ie. non-printable characters) are hidden. See "Control Codes" above.



(D) Log Window



Any log or status messages from NEWPRINT will appear here. This window can be turned on or off, but will receive messages even when hidden. This window has its own "Clear" button.

Sending Commands to NEWPRINT

NEWPRINT has the ability to accept commands from your computer's keyboard (user commands) or from a HTML WebSocket request (websocket commands).

In order to enter user commands, briefly press the command button on your NEWPRINT. The LED should turn blue . This indicates NEWPRINT is in "COMMAND" mode and ready to receive user commands. WebSocket commands are received and handled automatically and do not require that NEWPRINT be in command mode.

The NEWPRINT command button acts as a toggle. Pressing the button toggles between "COMMAND" mode (blue  LED) and "NORMAL" mode (red  or green  LED).

Note: After a user command is typed, the LED will blink once indicating the result of your command: Green  = valid, red  = invalid. After the single blink, it will turn back to blue  indicating you are still in command mode. Make sure to switch back to normal mode when you are done entering commands, otherwise NEWPRINT will attempt to interpret your printer output as user commands. If you are not seeing any NEWPRINT output, make sure you are in "NORMAL" mode.

User Commands (Computer → NEWPRINT)

Command	Description
SSID	Set wifi network name. If you need any special characters that your computer keyboard cannot generate you will need to use the SSIDHEX command instead.
SSIDHEX	Set wifi network name using hexadecimal values. See note #1 below.
PASS	Set wifi password
PASSHEX	Set wifi password using hexadecimal values. See note #1 below.
REBOOT	Reboot NEWPRINT. Settings are retained. Usually used after updating credentials, changing local/remote html setting, or changing server port.

You may also press the tiny "EN" button on the ESP32 chip (near the USB-C port) to reboot NEWPRINT. **NOTE:** You may also need to reboot your computer after rebooting NEWPRINT.

Note #1: Hexadecimal input is used when your SSID or password contains special characters you cannot type on the your keyboard. The hex values can be separated with a space if desired. Each character **MUST** be two case-insensitive digits (0-9, A-F).

There are many websites available to easily convert ASCII to HEX values.

<https://www.rapidtables.com/convert/number/ascii-to-hex.html>

TRS-80 Examples (assumes you are at the BASIC prompt) :

Set SSID name to "xxx"	LPRINT "SSID=xxx"
Set SSID name to "My_WIFI" using hex	LPRINT "SSIDHEX=4d 79 5f 57 49 46 49" LPRINT "SSIDHEX=4D795F57494649"
Set wifi password to "my_PASS#"	LPRINT "PASS=my_PASS#"
Set wifi password to "my_PASS#" using hex	LPRINT "PASSHEX=6d 79 5f 50 41 53 53 23" LPRINT "PASSHEX=6D795F5041535323"
Reboot NEWPRINT	LPRINT "REBOOT"

Apple II Examples (assumes you have already done a PR#1 to enable the printer) :

Set SSID name to "xxx"	SSID=xxx
Set SSID name to "My_WIFI" using hex	SSIDHEX=4d 79 5f 57 49 46 49 SSIDHEX=4D795F57494649
Set wifi password to "my_PASS#"	PASS=my_PASS#
Set wifi password to "my_PASS#" using hex	PASSHEX=6d 79 5f 50 41 53 53 23 PASSHEX=6D795F5041535323
Reboot NEWPRINT	REBOOT

Advanced/Experimental User Commands

<u>Command</u>	<u>Description</u>
DNSNAME	Change DNS name. See note #2 below. (default=newprint)
SERVERPORT	Set the web server port. See note #3 below. (default = 80)
SOCKETPORT	Set the web socket port. See note #3 below. (default = 8001)

Note #2: Most users should use the default setting (newprint). This setting is only necessary if you have more than one NEWPRINT running at the same time. Each NEWPRINT will need a different DNS name on your network. You must reboot your NEWPRINT before this change takes effect. The suffix ".local" is appended automatically and should not be entered.

Note #3: Experimental feature. You must reboot your NEWPRINT before new port settings take effect. **Web server and web socket ports cannot be the same.** Most users should use the default settings. Switching ports may be necessary if you already have services running on port 80/8001 or if you are writing your own interface. When using the default web server port you do not need to specify it in the browser address (ie. newprint.local). If you change the web server port setting then you will need to specify it in the browser address (ie. newprint.local:90). The web socket port is automatically updated in the HTML files served by NEWPRINT.

TRS-80 Examples:

Change DNS name to "m4printer.local" **LPRINT "DNSNAME=MYPRINTER"**
 Change the default web socket port **LPRINT "SOCKETPORT=9100"**

Apple II Examples:

Change DNS name to "m4printer.local" **DNSNAME=MYPRINTER**
 Change the default web socket port **SOCKETPORT=9100**

WebSocket Commands (web interface → NEWPRINT)

Note: These commands are sent via WebSocket API to NEWPRINT as a TEXT frame. The results may be TEXT or BINARY data as indicated below.

Name	Command	Description
About	"ABOUT"	Returns version and settings info (TEXT, prefix = ":ABOUT:")
Clear Buffer	"CLEAR"	Clears the NEWPRINT buffer (n/a)
Reboot	"REBOOT"	Reboot NEWPRINT. User settings are retained. (n/a)
OTHER	***	Most NEWPRINT settings can also be sent

* Most commands also return a frame with a log message (TEXT, prefix = **":LOG:"**).

Resetting NEWPRINT To Factory Defaults

If you ever need to reset NEWPRINT to factory default settings, hold the command button down for at least 3 seconds. Once the LED goes off, release the button and the NEWPRINT will reboot.

The LED should now be red  as there are no longer any wifi credentials to connect with.

If you wish to re-connect NEWPRINT to your network you will need to re-enter your SSID and password as described in the **Initial Setup** section of this guide.

Apple II Grappler+ Settings

Dip Switch Settings:

- "older" Grappler+ with 74LS373 chip in U10 need to have 1=Off
- "newer" Grappler+ card with 74LS374 chip in U10 need to have 1=
- Remaining switches should be set as 2=On, 3=On, 4=On

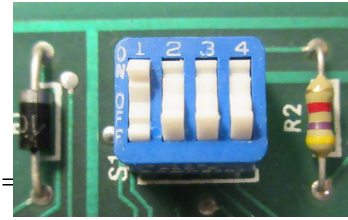

Apple II AppleWorks Classic (v1.2+) Settings

Support for AppleWorks when using NEWPRINT are fairly basic but should cover most standard output needs. The RTF output option in the NEWPRINT web interface will correctly interpret BOLD and underline text when enabled. The Save Output button will output as plain text (when RTF option is off), or as RTF format (when RTF option is on).

AppleWorks requires a certain control code setup when using NEWPRINT. These settings are set within the AppleWorks itself. This is necessary for NEWPRINT web interface to correctly interpret and display AppleWorks output.

Boot into AppleWorks on your Apple II.

Select "Other Activities" from the main menu

Select "Select Standard Settings for AppleWorks"

Select "Print Settings"

 Add an "ImageWriter II" or "EPSON FX Series" printer if it is not already set (slot 1)

Select Change Printer Specifications

Select Interface Cards

Is this OK? will be displayed. Pick the "No" option.

You need to enter "**Control-I ON**". Do this by:

- Hold Control key and press the I (Capital letter I) key once. Release the Control key.
- Now type a 0 (Zero) (Do not type any spaces)
- Next type a N (Capital letter N)
- Finally, type a ^ (Hold down the Shift key and press the 6 key) to end editing. Later versions use Open-Apple <RETURN> to end editing.

Your control characters are now set.

NOTE: You may want to also change the AppleWorks printer settings regarding margins, paper width, etc. These settings are set in the printer setup menus as well as individually in each document/report format.

Apple IIGS printing with GS/OS (Harmonie Drivers)

NEWPRINT supports generic Apple IIGS GS/OS printing when using a Grappler+ (or compatible) parallel card. Switch to the "PrintShop" display mode to see the output.

To use this feature you need to install parallel printer card drivers for GSOS. Harmonie works well and is recommended.

You need a few things:

- 1) Harmonie printer drivers (install the GrapplerPlus and ImageWriter II drivers from the Harmonie disk image). You can find these at:

<https://www.whatisthe2gs.apple2.org.za/harmonie-2-1>

- 2) "DC Printer" desk accessory (from GS/OS System Tools 1 disk - choose GrapplerPlus as port, ImageWriter II as type).

- 3) When printing (ie. from a GS/OS application), choose 160x144 dpi for best results. 80x72 DPI is a much higher speed but lower quality (ie. Draft mode). Compression setting will also speed up output considerably.

Writing a Custom Interface

NEWPRINT communicates over wifi using standard HTML WebSockets. This means that any client (web or desktop) that understands WebSockets can act as an interface.

The default socket address is: <ws://newprint.local:80>

The internal web server and web socket port is configurable with the PORT user command.

NEWPRINT uses two types of WebSocket payloads:

1. ArrayBuffer (Uint8 bytes) - Raw printer output
2. String (text) - Result of commands and other non-printer data. These messages start with unique identifiers so client applications can properly route them.
 - **:ABOUT:** = NEWPRINT firmware and user settings information.
 - **:LOG:** = Command responses that should be routed to a log window.

A good way to get a start on your own custom interface is to use your browser's "view source" command. This will reveal how the default NEWPRINT client is implemented.

Firmware Updates

The latest NEWPRINT firmware files are available at www.plaidvest.com

Note: Updating the firmware on an ESP32 microcontroller is fairly straightforward but does require a few command-line tools. If you would rather not attempt this yourself please contact support@plaidvest.com to arrange for a mail-in update. This service is free except for return postage costs.

To update the firmware you will need to upload the firmware file(s) to the ESP32 microcontroller via a USB-C cable, the esptool.py utility and a PC (Windows, Mac, or Linux). Google can provide instructions on how to install the "esptool" utility on your PC/Mac.

<https://github.com/espressif/esptool>

Note: Please unplug the NEWPRINT from your computer's printer port when performing this update. You also need to unplug the barrel jack power plug. The USB cable will provide power.

Updating the firmware should **not** erase your wifi credentials or other settings.

Here is a sample command line to upload the firmware. You may need to add the path to your esptool.py utility and the serial port name. The *.bin firmware files are in the zip file downloaded from www.plaidvest.com/newprint.

MAC - find serial port name with terminal command: `ls /dev/cu.*` after you plug in your NEWPRINT.

Command = `esptool.py`

Windows - find COM port name using Device Manager after you plug in your NEWPRINT. Look under "Ports (COM & LPT)".

Command = `python -m esptool`

```
=====
WHEN FLASHING FIRMWARE <= v1.4.3
=====
esptool.py \
--chip esp32 \
--port /dev/cu.usbserial-0001 \
--baud 921600 \
--before default-reset \
--after hard-reset write-flash -z \
--flash-mode dio \
--flash-freq 80m \
--flash-size detect \
0xe000 boot_app0.bin \
0x1000 newprint-multi.ino.bootloader.bin \
0x8000 newprint-multi.ino.partitions.bin \
0x10000 newprint-multi.ino.bin
```

```
=====
WHEN FLASHING FIRMWARE >= v2.0.0
=====
esptool.py \
--chip esp32 \
--port /dev/cu.usbserial-0001 \
--baud 921600 \
--before default-reset \
--after hard-reset write-flash -z \
--flash-mode dio \
--flash-freq 80m \
--flash-size detect \
0x1000 newprint-multi.ino.bootloader.bin \
0x8000 newprint-multi.ino.partitions.bin \
0xe000 boot_app0.bin \
0x10000 newprint-multi.ino.bin \
0x310000 littlefs-np-files.bin
```

Parallel Port Pinout

1	DATA_STROBE* (active low)	15	Data Bit 6
2	GND	17	Data Bit 7
3	Data Bit 0	19	ACK* (active low)
5	Data Bit 1	21	Busy
7	Data Bit 2	23	Paper Out
9	Data Bit 3	25	Online
11	Data Bit 4	28	Fault* (active low)
13	Data Bit 5		

FAQ (Frequently Asked Questions)

I am having trouble connecting the NEWPRINT to my wifi network.

Your credentials may be incorrect.

If you have any special characters in your network name (SSID) or password that your keyboard cannot generate you will need to use the hexadecimal versions of those commands. See the "**Commands**" section of this guide.

NEWPRINT ESP32 power LED is not on:

The ESP32 microcontroller has a very tiny, very bright, red power LED next to the USB-C port that should be lit whenever your NEWPRINT is connected to power. If this tiny light is not on then your power adapter might not be providing enough current. Please try using a different power adapter.

My commands are not recognized:

Make sure you are in "COMMAND" mode before entering commands. The LED needs to be blue 🟦 before entering commands from the keyboard. If it is not blue 🟦 then press the NEWPRINT command button once quickly.

Apple II printing not working or receiving "OUT OF PAPER" message

Please check your Grappler+ card dip switch settings.

Linux (USB-to-Parallel cable) Examples:

Adapter shows up as /dev/usb/lp0

Change permissions: `chmod +777 /dev/usb/lp0`

Send command: `echo -e "SSID=my_2.4_wifi\r" > /dev/usb/lp0`

Serial monitor: `picocom --imap 8bithex -b 115200 /dev/ttyUSB0`

macOS (USB-to-Parallel cable) Examples:

Setup NP printer as text-only using cups web interface.

Send command: `echo "SSID=kw_ap_2.4" | lp -d NP`

I am having a problem that is not listed above:

Please try resetting to factory defaults by holding the command button for 3 seconds. You will need to re-enter your SSID and password. If that doesn't seem to help, NEWPRINT uses a standard ESP32 microcontroller and related serial output log. If you connect your NEWPRINT to a PC or Mac with the USB-C cable and a terminal program at 115200 baud and you should be able to see logging/debugging messages.

See the espressif site for more information:

<https://docs.espressif.com/projects/esp-idf/en/latest/esp32/get-started/establish-serial-connection.html>

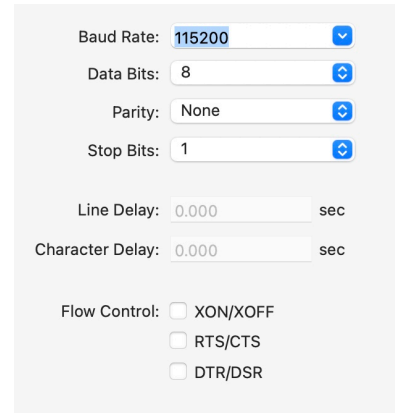

The image shows a screenshot of a serial port configuration interface. It includes the following settings:

- Baud Rate: 115200
- Data Bits: 8
- Parity: None
- Stop Bits: 1
- Line Delay: 0.000 sec
- Character Delay: 0.000 sec
- Flow Control: XON/XOFF, RTS/CTS, DTR/DSR

Contact/Questions/Comments/Bugs

Firmware and Installation & User Guide updates available at www.plaidvest.com

Send any questions or comments to support@plaidvest.com

Thank you for your feedback!